

一、工艺流程 Process Flow:

原料 Mateial

制程 Process

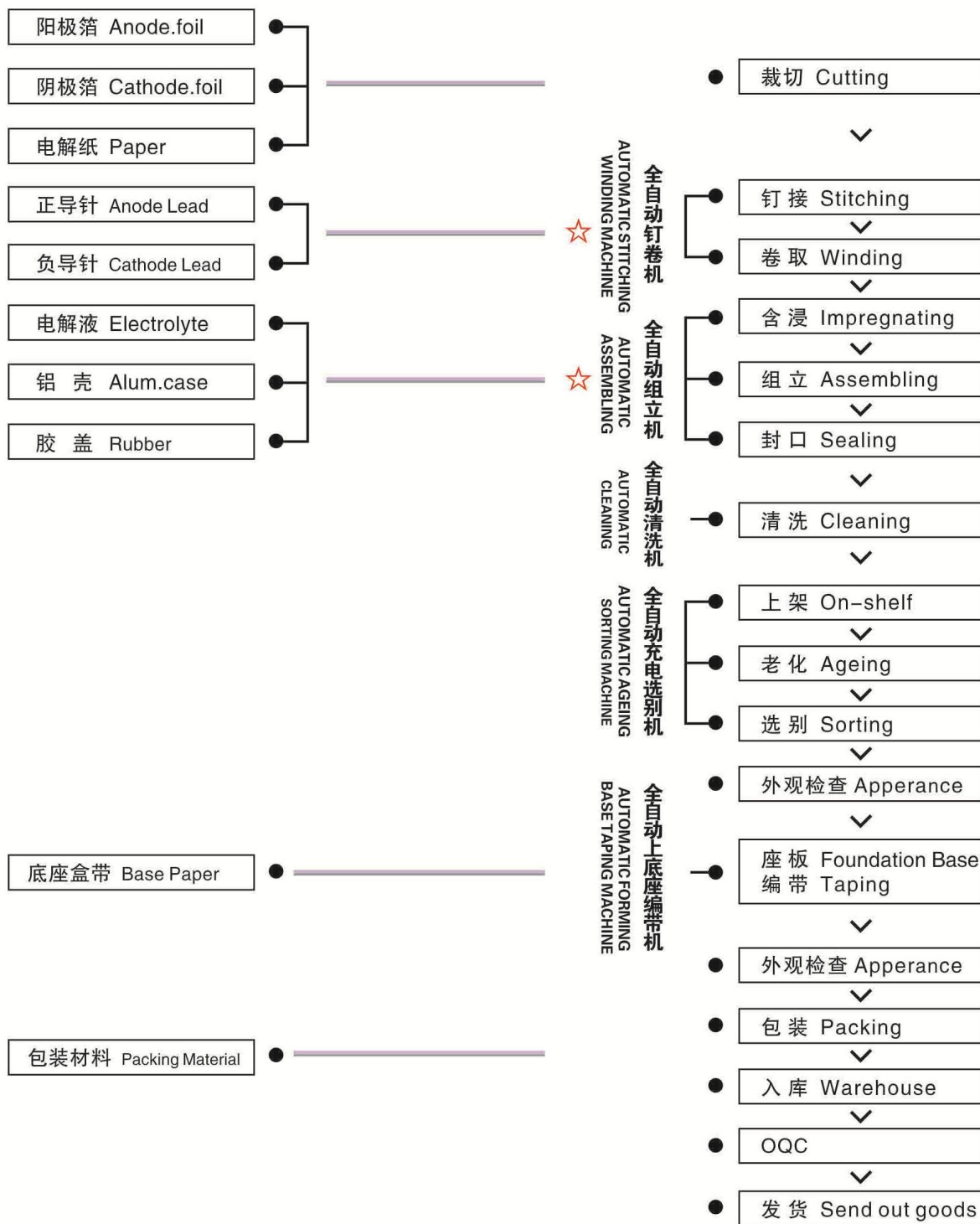

● 材料 ● 制程 = QC ∨ IPQC ★ 关键工序

二、结构 Construction:

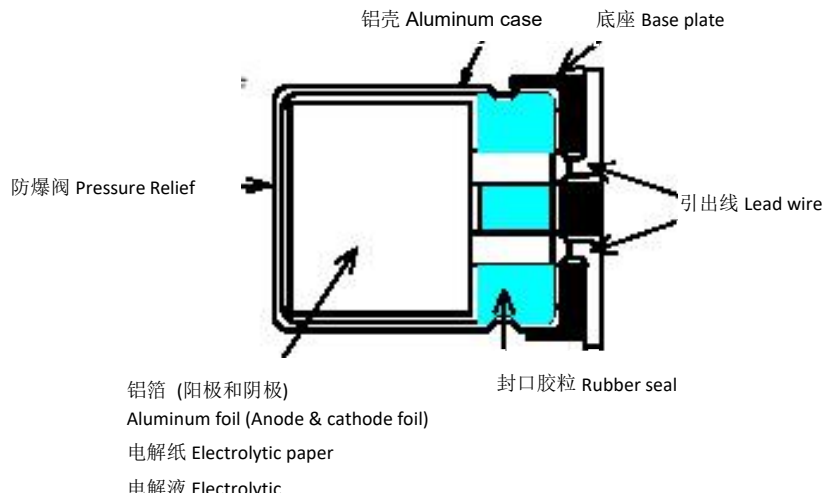

三、Part No.编写原则

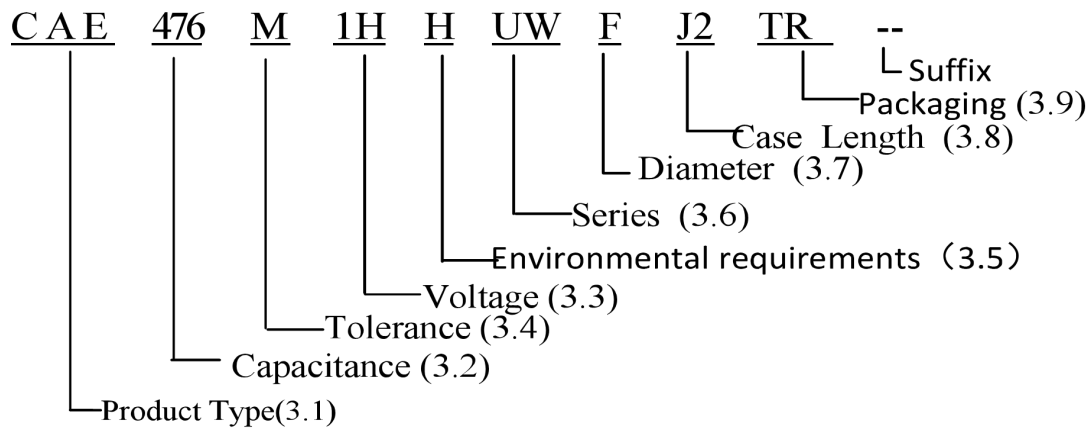

3.1 Product Type

Code	CAE
Product Type	V-CHIP

3.2 Capacitance code

Code	475	476	477
Capacitance (μF)	4.7	47	470

3.3 Rated voltage code

Code	0J	1A	1C	1E	1V	1H	1J	2C	2D	2E	2G	2W
Voltage (W.V.)	6.3	10	16	25	35	50	63	160	200	250	400	450

3.4 Capacitance tolerance

Code	M	K	V	Q	R
Tolerance Range	±20%	±10%	-10%~+20%	-10%~+30%	0~+20%

3.5 Environmental requirements

Code	R	H
Environmental requirements	ROHS Requirements	HF Requirements

3.6 Products Series Code:

Code	UW
Series	CDUW

3.7 Diameter

Code	B	C	D	E	F	G	I
Diameter	3	4	5	6.3	8	10	12.5

3.8 Case length

Code	E4	G7	J2	1A	1B	1C
Case Length(mm)	5.4	7.7	10.2	11.5	12.5	13.5

3.9 Packaging:

Code	RR	TR
Packaging	Bulk	Taping of Reel

3.10 Suffix: Inner Code

四、特点 Characteristics:

-标准大气条件(Standard atmospheric conditions)

测量和试验的大气条件的标准范围如下 Unless otherwise specified, the standard range of atmospheric conditions for making measurements and tests is as follows:

温度 Ambient temperature: 15°C to 35°C ; 湿度 Relative humidity: 45% to 85% ; 大气 Air Pressure: 86kPa to 106kPa

测量应在下列条件下进行 If there is any doubt about the results, measurement shall be made within the following conditions:

温度 Ambient temperature: 20°C ± 2°C ; 湿度 Relative humidity: 60% to 70% ; 大气 Air Pressure: 86kPa to 106kPa

详细性能, 请参阅表 1 As to the detailed information, please refer to table 1

Table 1

项目 Item	特性参数 Characteristics								
参考标准 Reference Standard	国际标准 IEC 60384 与日本工业标准 JIS C-5101 The international standard IEC 60384 and Japanese industrial standard JIS C-5101.								
环境保护标准: Environmental Protection Standard	遵照欧盟指令 2002/95/EC. Comply with the EU directive 2002/95/EC.								
使用温度范围 Operating Temperature Range	-40°C~+105°C								
额定电压范围 Rated Voltage Range	6.3~450V								
容量范围 Capacitance Range	1~1000μF								
容量允许偏差(20°C,120Hz) Capacitance Tolerance	±20% (M)								
漏电流(20°C) Leakage Current	6.3~50v dc				160V~450Vdc				
	I=0.03CV(μA) or 4 取较大者 Whichever is greater 2minutes				I≤0.04CV+100(μA) (after 2minutes)				
	Whichever is greater after 2 minutes I: Leakage Current(μA) C: Rated Capacitance(μF) V: Working Voltage(V)								
损耗角正切值(20°C,120Hz) Dissipation Factor	WV	6.3	10	16	25	35	50	160~250	400~450
	tanδ	0.32	0.28	0.26	0.16	0.14	0.14	0.20	0.24
低温特性 Low Temperature Stability	阻抗比 Impedance ratio (120 Hz)								
	Rated Voltage (V)	6.3	10	16	25	35~50	160~250	400~450	
	Z-25°C/Z+20°C (120Hz)	4	3	2	2	2	6	6	
Z-40°C/Z+20°C (120Hz)	10	8	6	4	3	10	18		

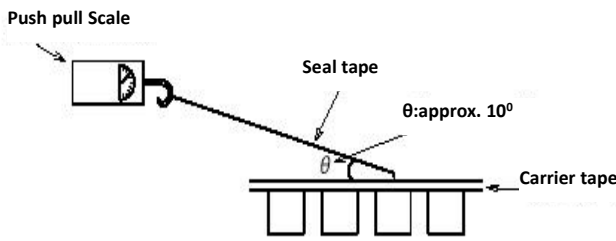
项目 Item	特性参数 Characteristics		
高温负荷特性 Load Life	105℃施加额定电压 10000 小时后，放置 16 小时后，电容器应满足以下要求： After applying rated voltage with max ripple current for 10000hrs at +105℃,and then resumed 16 hours, the capacitors Shall meet the following requirements.		
	Rated Voltage(V)	6.3~50V	160~450V
	容量变化率 Capacitance Change	±30%初始值内 Within ±30% of initial value	±20%初始值内 Within ±20% of initial value
	损耗角正切值 Dissipation Factor	≤300%初始规定值 Not more than 300% of the specified value	≤200%初始规定值 Not more than 200% of the specified value
	漏电流 Leakage Current	≤初始规定值 Not more than the specified value	≤初始规定值 Not more than the specified value
	高温贮存特性 Shelf Life	105℃贮存 1000 小时后，放置 16 小时后，电容器应满足以下要求： After storage for 1000hrs at +105℃, then resumed 16 hours, the capacitors Shall meet the following requirements	
Rated Voltage(V)		6.3~50V	160~450V
容量变化率 Capacitance Change		±30%初始值内 Within ±30% of initial value	±20%初始值内 Within ±20% of initial value
损耗角正切值 Dissipation Factor		≤300%初始规定值 Not more than 300% of the specified value	≤200%初始规定值 Not more than 200% of the specified value
漏电流 Leakage Current		≤300%初始规定值 Not more than 300% of the specified value	≤200%初始规定值 Not more than 200% of the specified value
耐焊接热： Resistance to Soldering Heat		在 250℃的条件下，电容器在热板上保持 30 秒，然后从热板上取下电容器， 让其在室温下恢复，电容器应满足以下要求： The capacitors shall be kept on then hot plate maintained at 250℃ for 30 seconds.After removing from the hot plate and restored at room temperature, they meet the following requirement :	
	容量变化率 Capacitance Change	±10%初始值内 Within ±10% of the initial value	
	损耗角正切值 Dissipation Factor	≤初始规定值 Not more than the specified value	
	漏电流 Leakage Current	≤初始规定值 Not more than the specified value	
	合理的拉伸强度 Reasonable pulling strength: 0.1~0.7N 牵引速度 Pulling speed: 300mm/min		
附着力试验 Adhesion test	合理的拉伸强度 Reasonable pulling strength: 0.1~0.7N 牵引速度 Pulling speed: 300mm/min		
	 <p>The diagram illustrates the adhesion test setup. A capacitor is mounted on a carrier tape. A seal tape is used to secure the capacitor to the tape. A push pull scale is attached to the capacitor, and a force is applied to pull it away from the carrier tape at an angle θ of approximately 10°. The carrier tape is shown with several other capacitor positions.</p>		

五：体积和最大纹波电流 CASE SIZE & MAX RIPPLE CURRENT

Size : ϕ D X L (mm) , Ripple Current (mA r.m.s./+105°C,120 Hz)

μ F	WV	6.3		16		25		35		50	
	ITEM	D×L	R.C.	D×L	R.C.	D×L	R.C.				
10								6.3x7.7	31		
22								6.3x7.7	43		
33						6.3x7.7	48			8x10.2	79
47								8x10.2	90	8x10.2	95
100	6.3x7.7	60	6.3x7.7	50	8x10.2	119	8x10.2	132	10x10.2	155	
220								10x10.2	220		
330	8x10.2	165	8x10.2	159							
470	8x10.2	196	8x10.2	194							
1000	10x10.2	315	10x10.2	260							

μ F	WV	160		200		250		400		450	
	ITEM	D×L	R.C.	D×L	R.C.	D×L	R.C.	D×L	R.C.	D×L	R.C.
1						6.3x10.2	20	6.3x10.2	17	8x10.2	20
2.2						6.3x10.2	31	8x10.2	30	10x10.2	35
3.3						8x10.2	43	10x10.2	39	10x10.2	38
4.7				8x10.2	53	8x10.2	52	10x10.2	56	10x10.2	59
5.6				8x10.2	58	8x12.5	62	10x10.2	66	12.5x13.5	75
6.8	8x10.2	68	8x10.2	64	10x10.2	72	12.5x13.5	72			
8.2	10x10.2	85	8x12.5	77	10x12.5	85					
10	10x10.2	95	12.5x13.5	110	12.5x13.5	110					
12	10x10.2	104	12.5x13.5	125	12.5x13.5	120					
15	12.5x13.5	140	12.5x13.5	140							

六：额定纹波电流的频率系数：Frequency Coefficient of Allowable Ripple Current

Frequency	120Hz	1kHz	10kHz	100kHz
Coefficient	1.00	1.60	1.80	2.00

标识：Marking

电容器标识内容如下：

Capacitors shall be legibly marked with the following:

产品系列：

Manufacture's mark

额定电压和额定电容量：

Rated voltage and nominal capacitance

负极标识：

Negative polarity

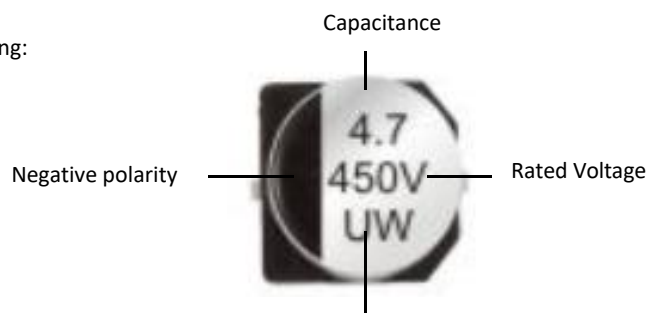

七：外型图 DIMENSIONS :

Ø4 ~ Ø6.3 Non explosion proof valve ,
 Ø8 ~ Ø12.5 Explosion proof valve

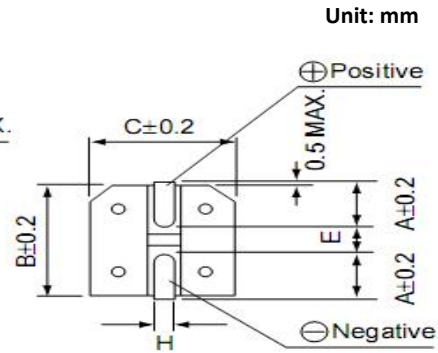
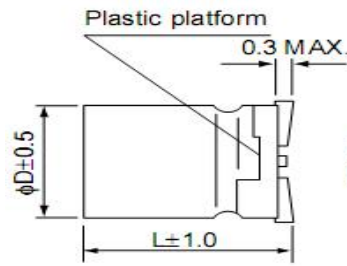
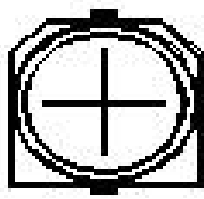

Unit: mm

尺寸：Dimensions (Unit: mm)

Size	Φ4×5.4	Φ5×5.4	Φ6.3×5.4	Φ6.3×7.7	Φ8×6.5	Φ8×10.2	Φ10×10.2	Φ12.5×13.5	Φ12.5×16
A	1.8	2.1	2.4	2.4	2.9	2.9	3.2	4.5	4.5
B	4.3	5.3	6.6	6.6	8.3	8.3	10.3	13.0	13.0
C	4.3	5.3	6.6	6.6	8.3	8.3	10.3	13.0	13.0
E	1.0	1.3	2.2	2.2	3.1(2.2)	3.1	4.5	4.0	4.0
L	5.4	5.4	5.4	7.7	6.5	10.2	10.2	13.5	16
H	0.5 ~ 0.9					0.8 ~ 1.1		1.0~1.4	1.0~1.4

八：编带说明： Taping Specifications

符合标准 JIS C0806 与 IEC 602863

Applicable standard JIS C0806 and IEC 60286.

盒带图样与尺寸 Carrier Tape and Dimension

Fig.1 (Ø4 ~ Ø10)

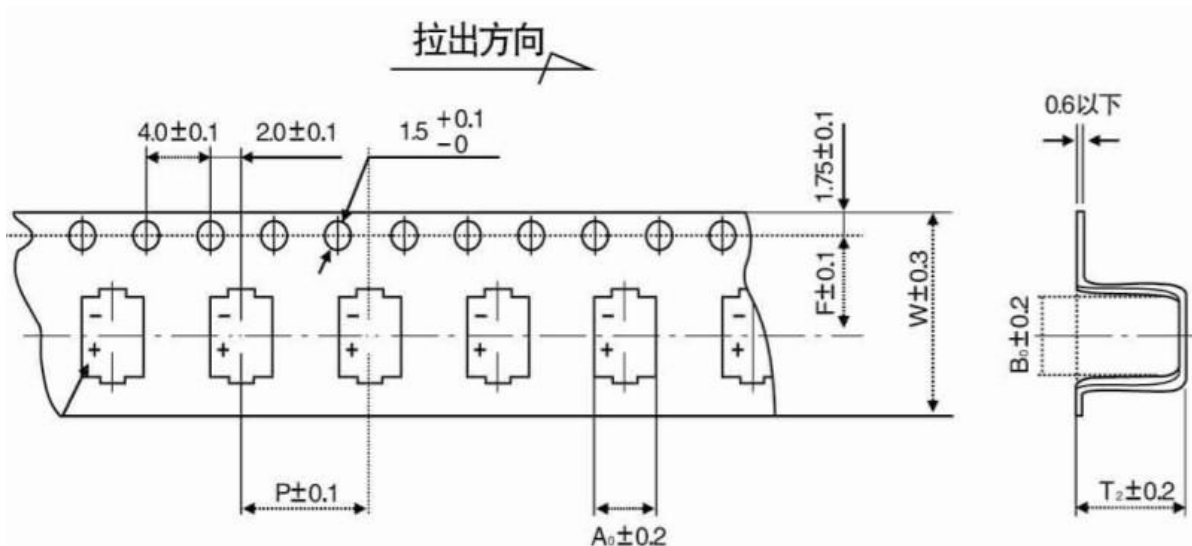
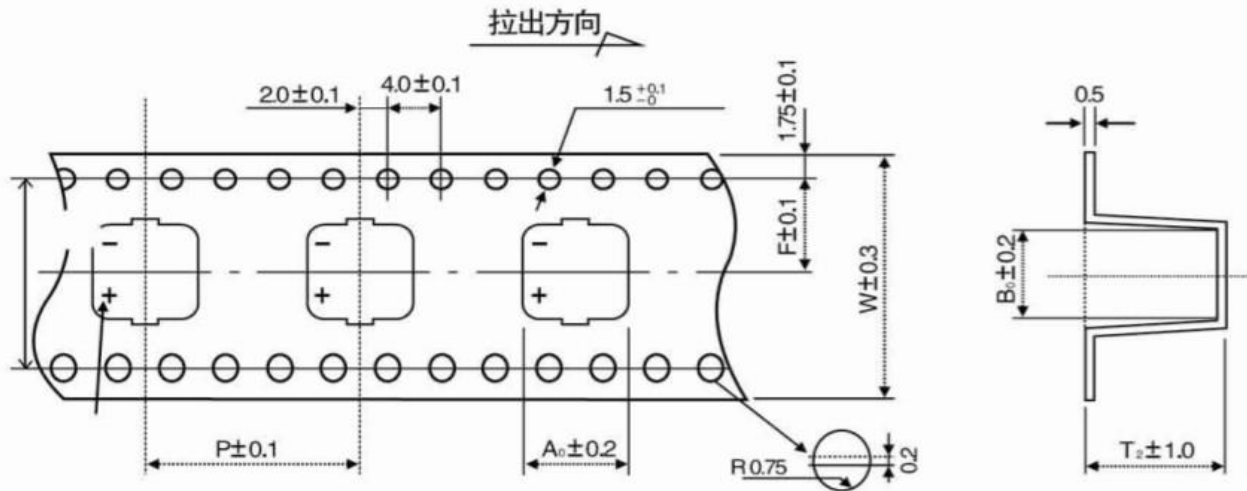

Fig.2 (Φ12 以上产品)



尺寸 Size	W (mm)	P (mm)	F (mm)	A ₀ (mm)	B ₀ (mm)	T ₂ (mm)	S	形状 Applicable
Φ4*5.4	12	8	5.5	4.7	4.7	5.8	--	Fig.1
Φ5*5.4	12	12	5.5	6.0	6.0	5.8	--	
Φ6.3*5.4	16	12	7.5	7.0	7.0	5.8	--	
Φ6.3*7.7	16	12	7.5	7.0	7.0	8.3	--	
Φ6.3*10.2	16	12	7.5	7.0	7.0	11.0	--	
Φ8*10.2	24	16	11.5	8.7	8.7	11.0	--	
Φ8*12.5	24	16	11.5	8.7	8.7	13.0	--	
Φ10*10.2	24	16	11.5	10.7	10.7	11.0	--	
Φ10*12.5	24	16	11.5	10.7	10.7	13.0	--	Fig.2
Φ12.5*13.5	32	24	14.2	14.0	14.0	14.1	28.4	
Φ12.5*16	32	24	14.2	14.0	14.0	16.4	28.4	
Φ16*16.5	44	28	20.2	17.5	17.5	16.9	40.4	
Φ16*21.5	44	28	20.2	17.5	17.5	21.9	40.4	
Φ18*16.5	44	32	20.2	19.5	19.5	16.9	40.4	
Φ18*21.5	44	32	20.2	19.5	19.5	21.9	40.4	

Packing Style

- (1). Carrier tape shall be reeled inside. (seal tape shall be outside)
- (2). End of the tape shall be inside to the reel physically as shown in the below figure and leader part of seal tape shall not be attached.

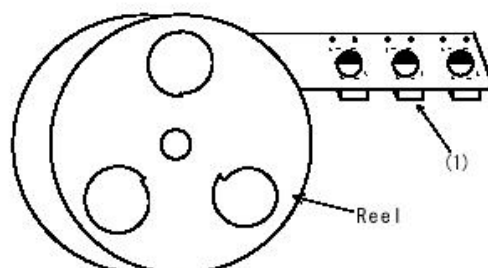

九：卷盘 : Reel

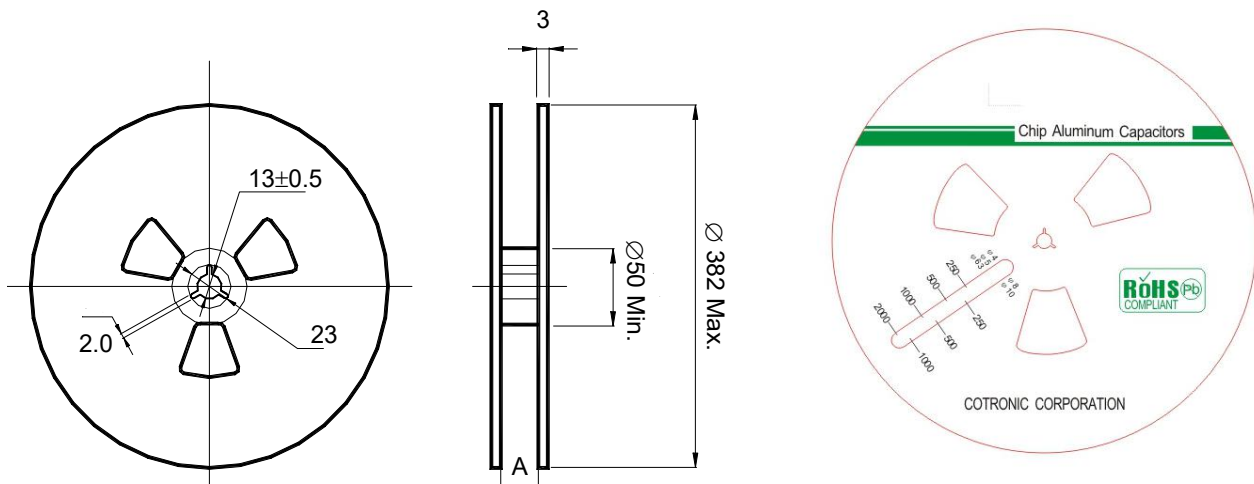

十：包装 Package:

1)数量: quantity:

规格 Specification	卷装数量(pcs) Quantity/Reel	盒装数量(pcs) Quantity/Bag	A±0.3 (mm)	B±2 (mm)
Φ4*5.4	2000	20000	14	382
Φ5*5.4	1000	10000	14	382
Φ6.3*5.4	1000	10000	18	382
Φ6.3*7.7	1000	10000	18	382
Φ6.3*10.2	700	7000	18	382
Φ8*10.2	500	5000	26	382
Φ8*12.5	400	4000	26	382
Φ10*10.2	500	5000	26	382
Φ10*12.5	400	4000	26	382
Φ12.5*13.5	200	1600	34	382
Φ12.5*16	200	1600	34	382
Φ16*16.5	200	1600	46	382
Φ16*21.5	150	1200	46	382
Φ18*16.5	150	1200	46	382
Φ18*21.5	100	800	46	382

2) Out-Box 、Label (外箱、标签) :

Out-Box	Label

十一：焊接适用性与方法：Welding methods and applicability.

焊接方法 Welding method	回流焊 Reflow soldering	烙铁 Soldering iron	波峰焊 Wave soldering
可行性 The feasibility of	○ 可行 feasible	○ 可行 feasible	× 不可行 Is not workable

无铅回流焊使用条件 Conditions for the use of lead-free reflow soldering.:

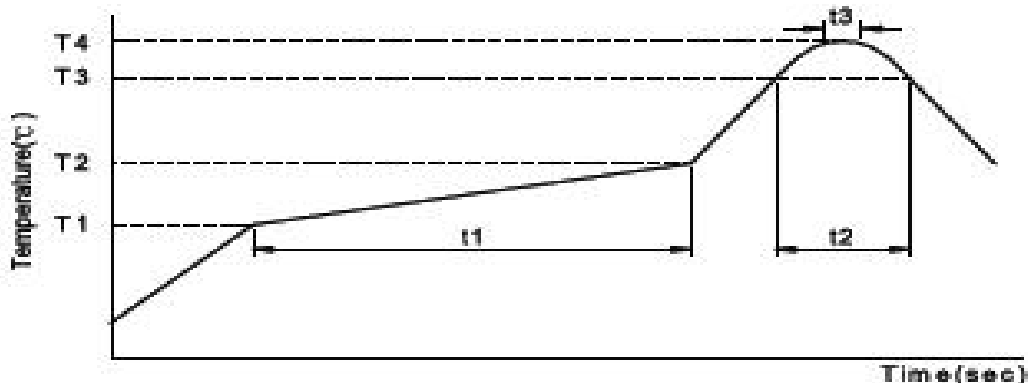

1) 方法如下 Methods the following:

- Reflow soldering: please follow the temperature condition during welding. If high temperature is used, please measure and inform the capacitor temperature and reflow soldering condition. The product size is larger and its rising temperature is slower. It is not necessary to adjust the temperature of the reflow solder in accordance with the size of the product. For example, the products of 4 and 10 will be installed in the PCB over tin furnace. 回流焊：在焊接时请遵循使用之温度条件。如使用较高之温度时，请量测并告知电容温度及回流焊条件。制品尺寸较大其上升的温度较缓慢。并非得依制品尺寸别调整回流焊锡炉的温度，例如：φ4 与 φ10 制品皆会安装于 PCB 过锡炉。

2) 焊锡注意事项 Precautions for soldering tin:

回流焊接温度的相关因素 Related factors of reflow soldering temperature:

制品尺寸 Product size: 制品尺寸较大其温度上升缓慢 The product size is larger and its temperature rises slowly.。

制品安装位置 Product installation position: PCB 中心的温度较 PCB 边缘温度低 The temperature of PCB center is lower than that of PCB.。

3) 反复回流焊 Reflow soldering:

如果可以，避免回流焊 2 次 f possible, avoid reflow soldering twice.。

如果反复回流是不可避免的，请量测并告知第一次与第二次的回流温度，以及回流焊之时间

If repeated reflux is unavoidable, measure and inform the first and second reflux temperature, and the time of reflow soldering.。

4) 请勿 3 次回流焊 Please do not 3 times of reflow soldering.。

以烙铁焊锡时请依循下列条件作业

Please follow the following conditions when soldering tin soldering:

焊接最高温度 Soldering iron maximum temperature: 350 ± 5°C

焊接时间 Welding time: 3+1/-0 秒

●测试方法及尖峰温度允许范围 Test method and peak temperature permissible range

制品类别 Products category	贴片铝电解电容器 SMD aluminum electrolytic capacitor							
额定电压 rated voltage (V)	4~50	4~50	≥63	4~100	≥160			
制品尺寸 Product size	4~6.3Φ × 4.5L	3~6.3	3~6.3	8~18	≥12.5			
预热 preheating	温度 Tem (T1~T2, °C)	150~180						
	时间 Time (t1) Max,秒 S	120	100					
持续时间 The duration of the	温度 Tem (T3, °C)	230	217	230	217	217	230	217
	时间 Time (t2) Max,秒	30	90	60	60	60	40	40
最高温度 The highest temperature	温度 Tem (T4, °C)	250	260		250	250		240
	时间 Time (t3) Max,秒	5						
回流次数 Return the number	1	≤2						

*如使用条件较上表所列为高时，请与我们联系 Please contact us if the conditions of use are higher than those listed above.。

*在执行第 2 次回流焊时，请确认电容器之温度已冷却至 5~35℃ When performing second reflow soldering, please make sure the temperature of capacitor has cooled to 5 ~ 35 °C。

*如回流焊条件依循 IPC/JEDEC(J-STD-020),请与我们联系 If the reflow condition is based on IPC/JEDEC(J-STD-020), please contact us.。

●OP-CAP 回流焊注意事项

回流焊会降低制品额定静电容量，应确认回流焊条件是否满足建议回流焊之规范

Reflow soldering will reduce the rated electrostatic capacity of the product, and it should be confirmed whether reflow soldering condition meets the specification of recommended reflow soldering.。

虽然实际的回流焊条件变更仍依据各项回流焊焊接方法，请注意制品铝壳底部之最高温度及电极端子不可超过最高温度 Although the actual reflow condition change is still based on the reflow soldering method, please note that the highest temperature and the electrode terminal at the bottom of the aluminum shell must not exceed the maximum temperature.

请特别注意 Please note: OP-CAP 制品在回流焊加热过程之温度应提高至 200℃ 以上 OP - CAP products during the process of reflow heating temperature should increase to more than 200 °C 。

若回流焊条件温度或持续时间) 大于上表所列，则 OP-CAP 制品会受损；制品静电容量降低约 50%、漏电流变大 (上升至数 mA) 以及损坏电容器外部 If the reflow condition temperature or duration is greater than the above table, the OP-CAP product will be damaged. The electrostatic capacity of the product is reduced by about 50%, the leakage current is large (up to mA), and the outside of the capacitor is damaged.

●表面安装推荐尺寸: Recommended Land Size (Unit: mm)

尺寸 Size	X	Y	a
Φ4	1.6	2.6	1.0
Φ5	1.6	3.0	1.4
Φ6.3	1.6	3.5	1.9
Φ8	2.5	3.5	3.0
Φ10	2.5	4.0	4.0

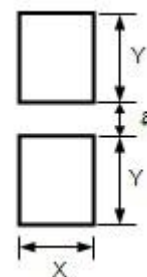

十二、片式铝电解电容器一般使用注意事项

Application guideline for V-CHIP aluminum electrolytic capacitors

A 电路设计 Circuit Design:

1)充分考虑电容器使用和安装条件在产品目录的规定范围内。

Please make sure the environmental and mounting conditions to which the capacitor will be exposed are within the conditions specified in catalogue.

2)工作温度和施加的纹波电流应在产品目录的规定范围内。

Operating temperature and applied ripple shall be within specification.

3)在设计电路时，应选择符合寿命要求的产品。

Appropriate capacitors which comply with the life requirement of the products should be selected when designing the circuit.

4)铝电解电容器是有极性的，不应加反向电压或交流电压。对可能出现反向电压的电路，应选择双极性电容器。注意：即使双极性电容器，也不能直接用于纯交流电路。

Aluminum electrolytic capacitors are polar. Make sure that no reverse voltage or AC voltage is applied to the capacitors. Please use bi-polar capacitors for a circuit that can possibly see reversed polarity.

Note: Even bi-polar capacitors cannot be used for AC voltage application.

5)对需要快速和频繁充放电的电路，不应使用铝电解电容器而应选择特别设计的具有长寿命的电容器。

Do not use aluminum electrolytic capacitors in a circuit that requires rapid and very frequent charge / discharge.

In this type of circuit, it is necessary to use a special design capacitor with extended life characteristics.

6)不应使用过载电压。

Do not apply excess voltage.

① 直流电压与纹波电压叠加后的峰值电压不应超过额定工作电压。

Please pay attention to that the peak voltage, which is DC voltage overlapped by ripple current, will not exceed the rated voltage.

② 若 2 个以上电容器串联，应确保施加电压低于额定值，而且要并联一个平衡电阻，以使每个电容器所加电压相等。

In the case where more than 2 aluminum electrolytic capacitors are used in series, please make sure that applied voltage will be lower than rated voltage and the voltage will be applied to each capacitor equally by using a balancing resistor in parallel with the capacitor

7)电容器不能应用于下述环境条件下：

Aluminum electrolytic capacitors shall not be used under the following environmental conditions:

①(a) 电容器被暴露于水（包括浓缩液）、盐水或油中。

Capacitors will be exposed to water (including condensation), brine or oil.

(b) 周围环境中存在有硫化氢、亚硫酸、亚硝酸、氯气、溴气、溴化甲烷、氨气等有毒气体。

Ambient conditions that include toxic gases such as hydrogen sulfide, sulfurous acid, nitrous acid, chlorine, bromine, methyl bromide, ammonium, etc.

(c) 周围环境中存在有臭氧、紫外线及辐射。

Ambient conditions that expose the capacitor to ozone, ultraviolet ray and radiation.

② 严重的振动及机械冲击超过产品目录的规定范围。

Severe vibration and physical shock conditions that exceed specification.

振动的测试条件如下

Vibration test condition:

振动频率范围 : 10-55-10Hz

vibration frequency range : 10~55~10Hz

扫描频率 : 10-55-10Hz/分钟

sweep rate : 10~55~10Hz/minute

扫描方式 : 对数

sweep method : logarithmic

振幅或加速度 : 1.5mm (最大加速度为 10G)

amplitude or acceleration : 1.5mm (max. acceleration is 10G)

振动方向 : X、Y、Z 方向

direction of vibration : X, Y, Z direction

测试时间: 每个方向 2 小时

testing time: 2 hours per each direction

冲击一般不适用.

Shock is not applicable normally.

如有特殊要求, 请与我们联系.

If a particular condition is required, please contact our sales office.

8) 电解液主要化学溶剂及电解纸为易燃物, 且电解液导电。当电解液与 PC 板接触时, 可能会腐蚀 PC 板上的线路, 或造成短路, 以致产生烟或着火。因此在电容器封口下端不应有任何线路。

The main chemical solution of the electrolyte and the separator paper used in the capacitors are combustible. The electrolyte is conductive. When it comes in contact with the PC board, there is a possibility of pattern corrosion or short circuit between the circuit pattern, which could result in smoking or catching fire. Do not locate any circuit pattern beneath the capacitor end seal.

9) 设计线路板时应确保发热元器件不靠近铝电解电容器或 PC 板的另一面, 避免其正好在电容器下面。

Do not design a circuit board that the heat generating components are placed near the aluminum electrolytic capacitor or on the reverse side of PC board, if that just under the capacitor.

10) 设计线路板时应考虑到电容器的电性能可能随温度和频率的变化而变化。

Electrical characteristics may vary depending on changes in temperature and frequency. Please consider this variation when you design circuits.

11) 当 2 个以上电容器并联时, 应考虑到通过这些电容器的电流平衡。

When you install more than 2 capacitors in parallel, please consider the balance of current flowing into the capacitors.

12) 在双面线路板上安装电容器时, 电容器的安装位置应避开多余的基板孔和过孔。

While mounting capacitors on double-side PC board, the capacitors should be away from those unnecessary base plate holes and connection holes.

B) 安装 Mounting

1) 一旦电容器经过安装及加载, 不要再试图用于其他线路板或其他用途。

Once a capacitor has been assembled in the set and power applied, do not attempt to re-use the capacitor in other circuits or application.

2) 贮存超过 2 年的电容器, 其漏电流可能增大。若漏电流增大, 请使用 1kΩ 电阻做充电处理。

Leakage current of the capacitors that have been stored for more than 2 years may increase. When leakage current has increased, please perform a voltage treatment using a 1kΩ resistor.

3) 在将电容器安装在 PC 板之前, 请确认其规格和极性。

Please confirm specifications and polarity before installing capacitors on the PC board.

4) 不要将电容器掉在地上, 或不要使用掉在地上的电容器。

Do not drop capacitors on the floor, nor use a capacitor that was dropped.

5) 安装时请不要损伤电容器。

Do not deform the capacitor during installation.

6) 请注意贴片机的吸头、产品检测夹具或对中装置对电容器的机械冲击。

Please pay attention to the mechanical shock to the capacitor by suction nozzle of the automatic insertion machine or automatic moulder, or by product checker, or by centering mechanism.

C) 回流焊 Reflow soldering

① 请遵守产品目录中的回流焊条件。

Please follow "Reflow Soldering Conditions" in catalogue.

- ② 当使用红外线加热时，请注意加热程度，因为红外线吸收率会随着电容器颜色和大小不同而改变。

When an infrared heater is used, please pay attention to the extent of heating since the absorption rate of infrared will vary due to difference in the color and size of the capacitor.

- 1) 将电容器焊接在 PC 板后，不要倾斜或扭动电容器。

Do not tilt lay down or twist the capacitor body after the capacitor are soldered to the PC board.

- 2) 不要抓住焊接后的电容器搬动 PC 板。

Do not carry the PC board by grasping the soldered capacitor.

- 3) 不要让任何物品接触焊接后的电容器,如果 PC 板堆放储存, 请确保 PC 板或其他零部件不触到电容器。

Please do not allow anything to touch the capacitor after soldering. If PC boards are stored in stack, please make sure the PC board or other components away from the capacitor.

- 4) 焊接后的电容器不应受到任何已焊接 PC 板或其他元器件热辐射的影响。

The capacitors shall not be effected by any radiated heat from the soldered PC board or other components after soldering.

- 5) 清洗:

Cleaning

- ① 不能用卤化清洗剂清洗电容器。如必须使用卤化清洗剂，请与我们销售部门联系。

Do not clean capacitors with halogenated cleaning agent. However, if it is necessary to clean with halogenated cleaning agent, please contact our sales office.

- ② 推荐清洗方法:

Recommended cleaning method

使用范围: 任何类型及规格

Applicable : Any type, any ratings

清洗方法: 浸泡、超声波或其他方法的总清洗时间应在 2 分钟内。清洗剂温度应在 40℃ 以下。清洗后, 应将电容器与 PC 板一起用热风吹至少 10 分钟。热风温度应低于电容器工作温度。水洗后若不充分吹干, 可能导致外观不良, 如座板发胀等。

Cleaning conditions : Total cleaning time shall be within 2 minutes by immersion, ultrasonic or other methods. Temperature of the cleaning agents shall be 40℃ or below. After cleaning, capacitors should be dried by using hot air for the minimum 10 minutes along with the PC board mounted. Hot air temperature should be within the maximum operating temperature of the capacitor. Insufficient dryness after water rinse may cause appearance problems, such as bottom-plate bulge and etc.

- ③ 避免使用破坏臭氧层的清洗剂以保护环境。

Avoid using ozone destructive substances as cleaning agents for protecting global environment.

D) 安装后 In the Equipment

- 1) 不要直接用手接触电容器正负极。

Do not directly touch terminal by hand.

- 2) 不要在正负极之间用导体连接, 也不要再在电容器及其附近溅撒导电液体, 如酸碱溶液等。

Do not link positive terminal and negative terminal by conductor, nor spill conductible liquid such as alkaline or acidic solution on or near the capacitor.

- 3) 在使用环境中应避免溅上水或油, 避免阳光直射、紫外线照射、辐射、有毒气体、振动或机械冲击。

Please make sure that the ambient conditions where the set is installed are free from spilling water or oil, direct sunlight, ultraviolet rays, radiation, poisonous gases, vibration or mechanical shock.

E) 维护和检验 Maintenance and Inspection

请定期检测安装在工业设备上的电容器。检测项目如下：

Please periodically inspect the aluminum capacitors that are installed in industrial equipment. The following items should be checked:

外观：明显缺陷，如防爆阀打开、电解液泄露等。

Appearance: remarkable abnormality such as pressure relief vent opening, electrolyte leaking, etc.

电性能：电容量、损耗角正切、漏电流等，具体数据参见产品目录和相关产品规格书。

Electrical characteristics: capacitance, dielectric loss tangent, leakage current and etc., which are specified in catalogue or alternate product specification.

F) 紧急情况 In an Emergency

1) 若看见因防爆阀动作而产生的烟气，请关闭主开关或拔开离合器。

If you see smoke due to operation of safety vent, please turn off the main switch or pull out the plug from the outlet.

2) 若吸入气体或咽下电解液，应立即用水清洗口腔和喉咙。

If you breathe the gas or ingest the electrolyte, please wash out your mouth and throat with water immediately.

3) 若皮肤沾上电解液，请用肥皂和水清洗干净。

If your skin is exposed to the electrolyte, please wash it away using soap and water.

G) 储存 Storage

1) 不要将电容器储存在温度和湿度高的地方，储存环境应为温度：5℃-35℃，相对湿度：<75%，储存地点：室内。

Do not keep capacitor in high temperature and high humidity atmosphere. Storage conditions should be:

Temperature: 5℃~35℃ Humidity : lower than 75% Place : Indoor

2) 避免电容器的储存环境中水、盐水或油。

Avoid ambient conditions where capacitors are covered with water, brine or oil.

3) 避免电容器暴露在臭氧、紫外线或辐射中。

Avoid ambient conditions where capacitors are exposed to ozone, ultraviolet ray or radiation.

H) 处置 Disposal

请用下面任何一种方法处置电容器：

Please take either of the following methods in disposing capacitors.

1) 在电容器壳体上开孔或将电容器压碎后焚烧。

Incinerate them after crushing capacitors or making a hole on the capacitor body.

2) 如不能进行焚烧，请交给废物处理机构进行填埋。

If incineration is not applicable, hand them over to a waste disposal agent and have them buried in landfills.

※**详细内容请参阅 JEITA RCR-2367B**

JEITA RCR-2367B

《电子机器用固定铝电解电容器使用注意事项指南》

For further details

Please refer to: JEITA RCR-2367B (Safety Application Guide for fixed aluminum electrolytic capacitors for use in electronic equipment).